

USER MANUAL

Heart Rate Monitor
Model: HRM308

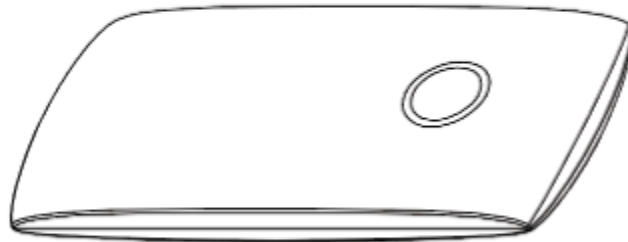

HEART RATE

Congratulations

Thank you for purchasing the Rechargeable Heart Rate Monitor. The Rechargeable Heart Rate Monitor can transmit heart rate data to a receiving device in a club as well as to a fitness app in real-time to track your exercise. This device has an IP67 waterproof rating.

IMPORTANT: This product is for sport purpose only and it is not meant to replace any medical advice. (Patients with cardiac pacemaker or other implantable devices should consult their doctors for recommendations)

Specifications

Connectivity: BLE(25 meters), ANT+(10 meters)
Battery: Rechargeable lithium battery 70mAh
Battery Life: Last 50 hours after being fully charged
Dimension: 59.5x27x10.4mm
Host weight: 12g
Waterproof: IP67
Operating Temperature: 5°C~40°C

What's in the box



Main Device x1

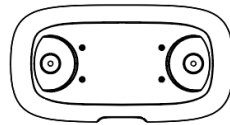

Charging Base x1

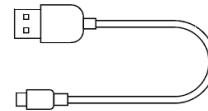

TYPE-C Cable x1

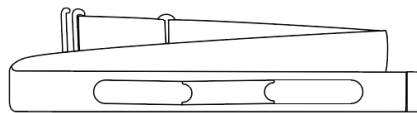

Chest Strap x1



User Manual x1

- 1 -

Instructions

NOTE: When the Rechargeable Heart Rate Monitor is on the strap and not worn, it will be off and enter sleep mode. Once the Rechargeable Heart Rate Monitor is worn around the chest strap, it will be automatically turned on and is now searchable.

How to Wear the chest strap

1. It is recommended to moisten the electrode areas of the chest strap (see below) for better signal connection



2. Attach the Rechargeable HRM to the chest strap and secure the strap across your chest. To ensure an accurate heart rate signal, adjust the strap until it fits snug below your chest.

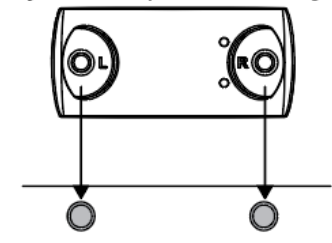

3. Adjust the strap until it fits snug below your chest. Make sure that the moist electrode areas are firmly against your skin. Pay attention to make sure the LED is on the left side towards your left arm. (As the figure show)

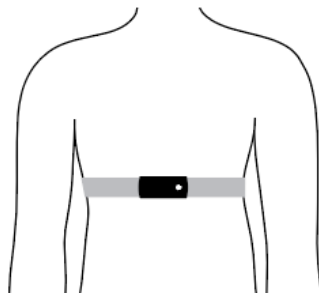

- 2 -

Heart Rate LED Color

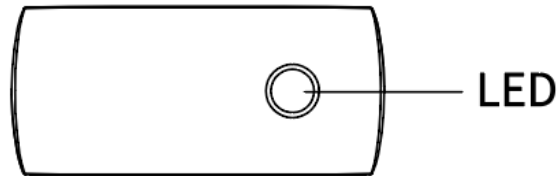

Once the Rechargeable Heart Rate Monitor is worn properly, the device will give an audible alert, and the LED will start flashing white indicating the device is on. When you remove the device from the chest strap you will hear 3 audible alerts and LED will turn off indicating the device is off. When the heart rate is detected, the LED will display green color.

Charging your HRM

1. Recommend to fully charge your Heart Rate Monitor before using for the first time.
2. Connect the charging cable to the charger and then plug the USB side of the connect to a USB power source.
3. The LED shows red during charging and will show green after the Heart Rate Monitor is fully charged.

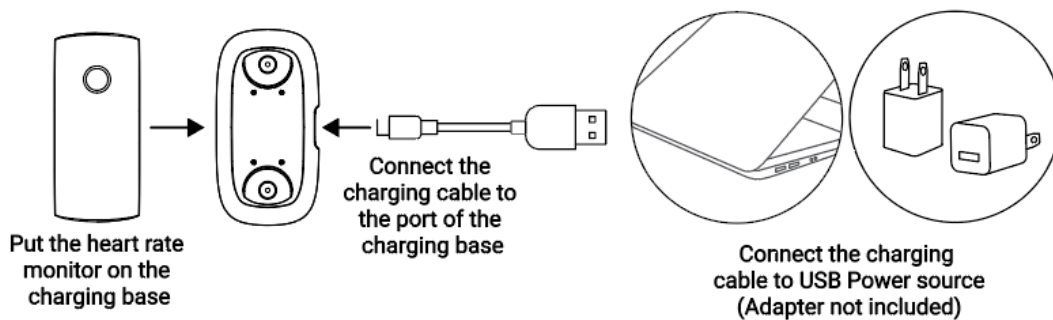

Compatible with Multiple Fitness Apps

Accuro/MooFit / Endomondo / Sports Tracker / Runtastic / Wahoo Fitness

Supported Firmware:

 IOS9.0 or above, iPhone 5s and above models

 Android 4.3 and above,

Disclaimer

- The information contained in this manual is for reference only. The product described above may be subject to change.
- We shall not bare any legal responsibility for any direct or indirect, accidental or special damages, losses and expenses arising from or in connection with this manual or the contained product.

FCC Statement

Changes or modifications not expressly approved by the party responsible for compliance could void the user's authority to operate the equipment.

This equipment has been tested and found to comply with the limits for a Class B digital device, pursuant to Part 15 of the FCC Rules. These limits are designed to provide reasonable protection against harmful interference in a residential installation. This equipment generates uses and can radiate radio frequency energy and, if not installed and used in accordance with the instructions, may cause harmful interference to radio communications. However, there is no guarantee that interference will not occur in a particular installation. If this equipment does cause harmful interference to radio or television reception, which can be determined by turning the equipment off and on, the user is encouraged to try to correct the interference by one or more of the following measures:

- Reorient or relocate the receiving antenna.
- Increase the separation between the equipment and receiver.
- Connect the equipment into an outlet on a circuit different from that to which the receiver is connected.
- Consult the dealer or an experienced radio/TV technician for help

This device complies with part 15 of the FCC rules. Operation is subject to the following two conditions (1) this device may not cause harmful interference, and (2) this device must accept any interference received, including interference that may cause undesired operation.